



Instructions for use

ConnectionCenter

Field of application

The ConnectionCenter 3200 is used as a basis for refillable cartridges. It supplies softened, fully demineralised or demineralised water with pH value stabilisation for heating systems in accordance with VDI Guideline 2035 Part 1 and protects heating systems against lime deposits.

Design

The Connection Center includes a digital capacitance control with integrated conductivity measurement, a shut-off valve on the output side, a sampling port for soft water, a water hardness tester and a wall bracket for mounting.

The upper part of the digital capacity control can be rotated in 90° steps after loosening the screws.

Please order the already filled cartridges, which are available in 2.5, 4, 7, 14 and 30 litre versions for HWE (heating water softening) HVE (heating demineralisation) and HVE Plus (pH value stabilisation) and can be refilled with the corresponding granulate.

Installation

Mount the supplied wall bracket on the wall.

The connection centre is equipped with 4 mounted pressure gauge plugs.

Remove the pressure gauge plugs on the outlet side in the direction of flow.

Attach the Connection Center to the wall bracket on one side and lock it in place using the screw connections.

Mount the drain valve on the other outlet side.

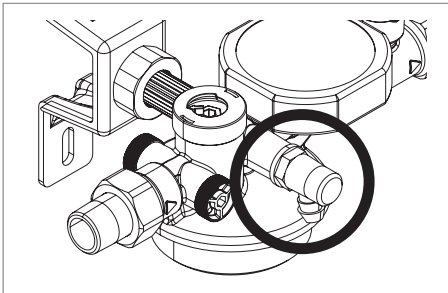

Screw the cartridge under the connection center (2).

Note: When using the 14 and 30 litre cartridges, the strainer in the connection centre is not required and can be removed! The cartridge is screwed directly onto the Connection Center.

Please remove the O-ring on the connection center before mounting these cartridges.

(see separate instructions for the 14 and 30 litre cartridges 9.3200.43)

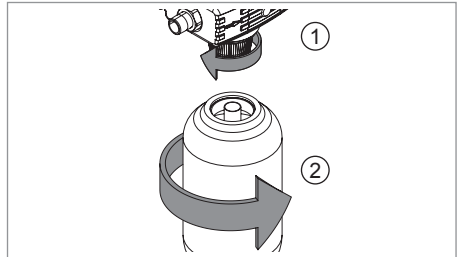

Note: The installation of a BA Backflow Preventer (e.g. BA 6628 Filling Combi) in flow direction upstream of the Connection Center is mandatory according to DIN EN 1717!

Preparation HWE / HVE / HVE Plus

Use the water hardness tester to determine the raw water hardness. Draw raw water from any tap in front of the heating system and measure the hardness of the water.

Digital capacity control

The digital capacity control includes the following elements:

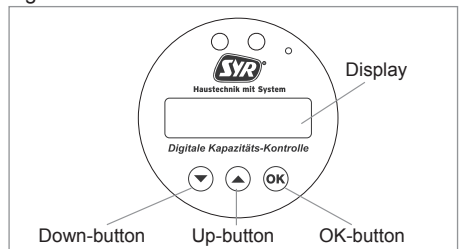

The display is switched off on delivery.

Press any key to switch the display on (the version number is displayed and the remaining quantity of the standard setting 1166 litres).



To change the values, press the **OK** button for at least 3 seconds.

Adjust raw water hardness

You are asked to enter the raw water hardness:



Press the **▼** - or **▲** button to change the value and press **OK** to save.

Select Cartridge

Specify the cartridge used in two steps.

Select the type of water treatment (HWE, HVE, HVE plus) with the **▼** - or **▲** button and save with the **OK** button.



Select the size of the cartridge (2.5, 4, 7, 14 or 30 litres) with the **▼** - or **▲** button and save with the **OK** button.



Adjust soft water hardness

You are asked for the desired soft water hardness.

Attention: This query is not necessary if you are using a HVE cartridge!



Press the **▼** - or **▲** button to change the value and press **OK** to save.

Before filling, check the initial hardness of the water by drawing 2-3 litres of water through the drain valve and checking it with the water hardness tester.

If necessary, adjust the soft water hardness setting.

Adjust conductance monitoring

Attention: This query only appears when using the HVE / HVE Plus cartridge!

You have the option to switch off (OFF) or activate conductivity monitoring.



When conductivity monitoring is activated, you can set limit values from 10 - 200 μ S.



Press the **▼** - or **▲** button to change the value and press **OK** to save.

Cartridge replacement

Finally, you must indicate whether the cartridge has been changed or refilled.



Press the **▼** - or **▲** button to confirm (Yes) or reject (No) the cartridge change.

If you have selected „Yes“, press the **OK** button for 3 seconds to confirm the cartridge change and save the change.

The following confirmation appears:



When all settings have been completed, the display shows the new calculated remaining quantity in litres.

Note: After each cartridge change, the settings „Raw water hardness“, „cartridge“, („Soft water hardness“) must be made again!

Adjustment of HWE / HVE

Set the desired mixed water hardness using a hexagon socket wrench on the blending valve.

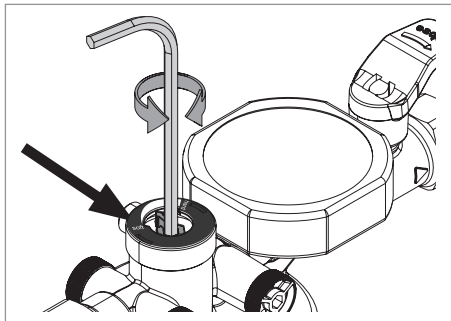

For soft water, turn in the „Soft“ direction, for harder water turn to „Hard“.

Note: When using the HVE cartridge, set the blending valve to „Soft“!

The system can now be filled.

Technical specifications

max. operating pressure: 6 bar
max. operating temp.: 30°C
Fluid: Trinkwasser
Flow rate: 0,5 m³/h

Displays

During filling, the display shows the current flow volume.

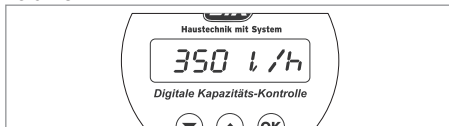

If there is no flow, a simple press of the button  displays the volume recorded so far since the last cartridge change.

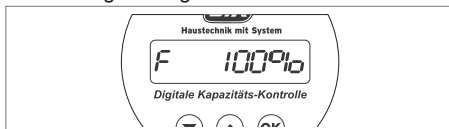

If the battery needs to be replaced, the following message is displayed.

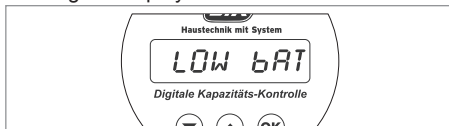

To replace the battery, unscrew the cover and replace the battery (CR-2032). **Pay attention to the correct polarity!**

When the capacity of the cartridge is almost exhausted (10 - 1 % remaining capacity) the message „Cartridge almost exhausted“ is displayed.

When the cartridge is completely exhausted, the message „Cartridge exhausted“ appears - the cartridge must be replaced!